

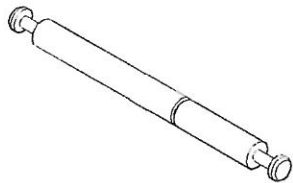

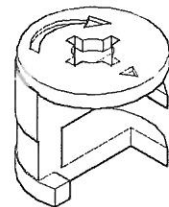



ESTANTERÍA DE CUBOS - 6606

					
PERNO DOBLE(x4)	EXCÉNTRICAS(x28)	TOPE-CLAVO(x4)	TAPÓN EXCÉNTRICA(x8) 15mm	TAPÓN EXCÉNTRICA(x20) 4x17mm	PERNOS (x20)

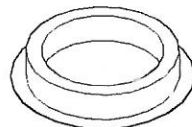
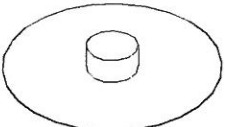
MONTAJE DE LA ESCUADRA

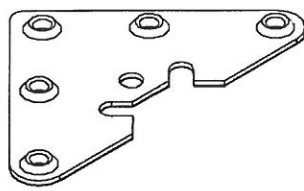
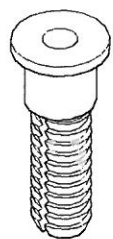
DESPIECE

	
ESCUADRA(x2)	TACO PLAST.(x2)
	
4X20(x10)	4X35(x2)

- LI=LATERAL IZQUIERDO(x1)
- LD=LATERAL DERECHO(x1)
- LC=LATERAL CENTRAL(x1)
- B=BALDAS(x4)
- TAPA=SUELO(x2)

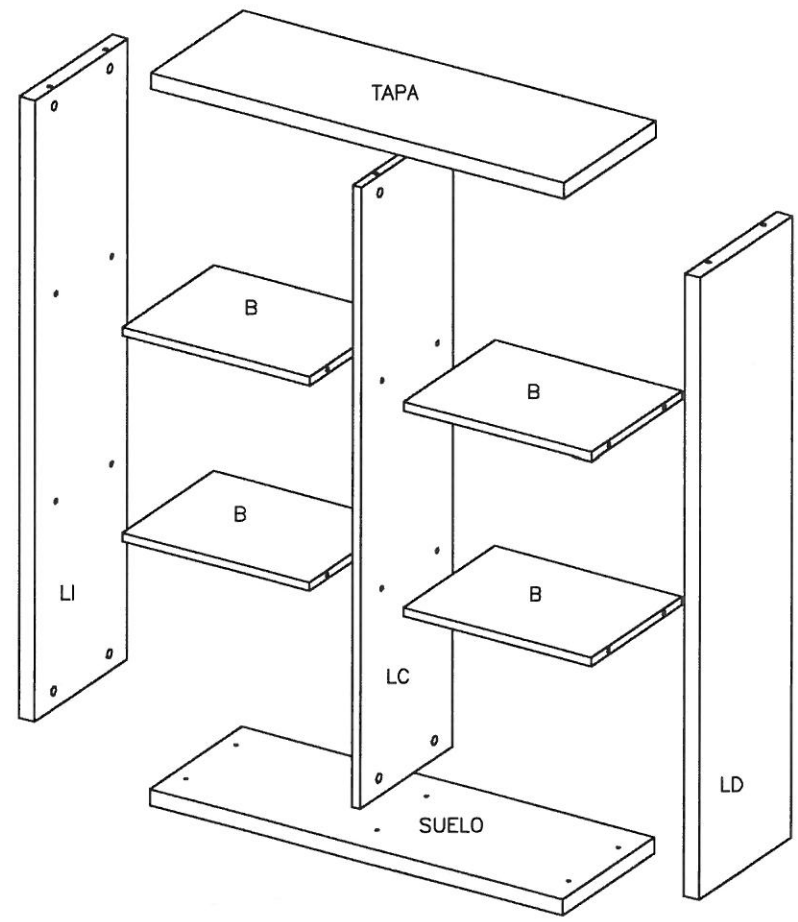

PASO I – 6606

PIEZAS PARA ESTE PASO

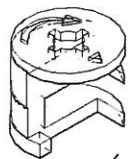

(x8)

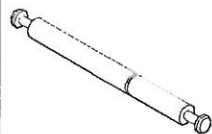

EXCENTRICAS

PERNO DOBLE(x4)

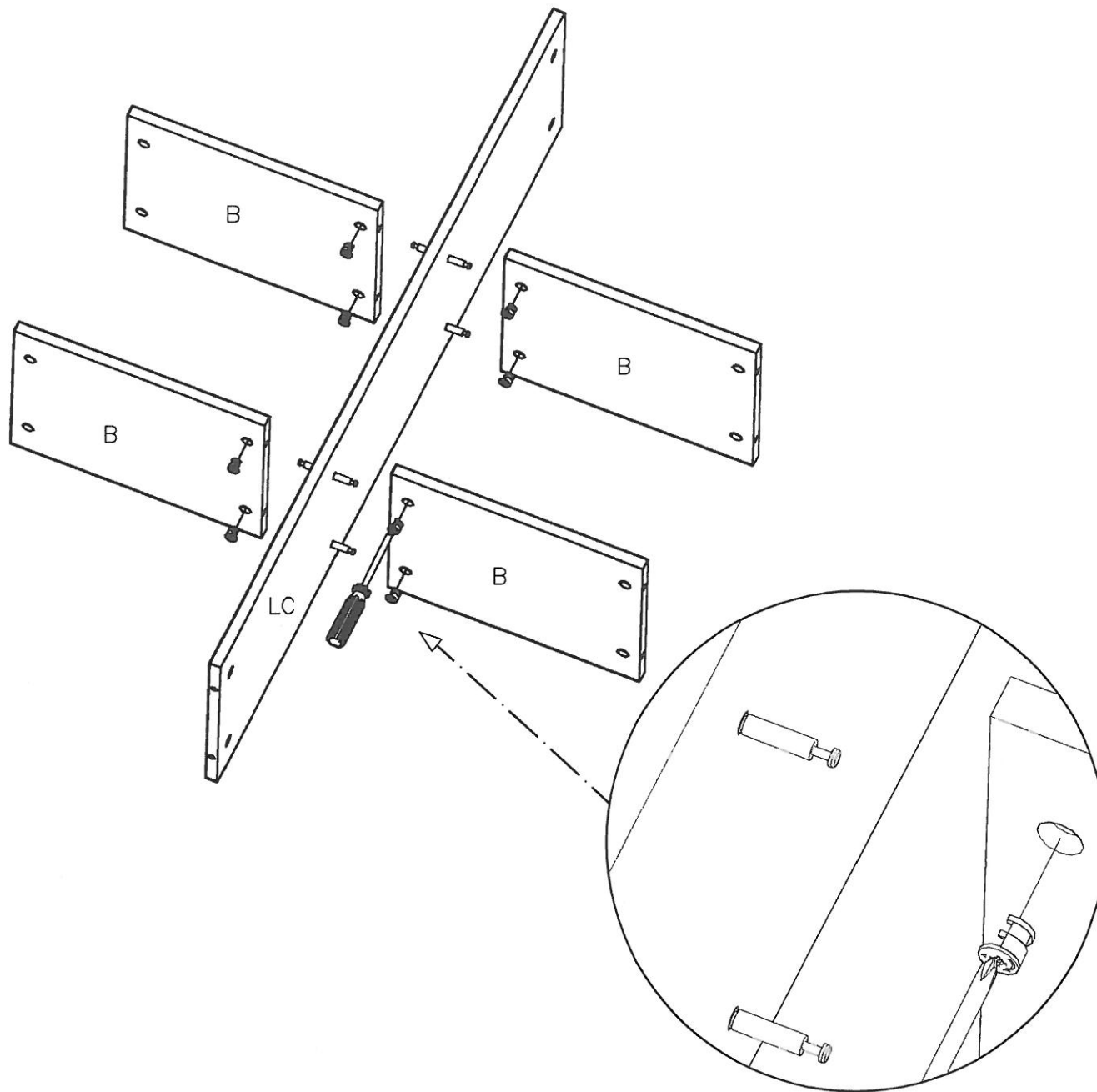

PASO II – 6606

PIEZAS PARA ESTE PASO

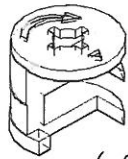

(x20)



EXCENTRICAS PERNO (x20)

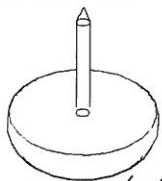

(x4)

TOPE-CLAVO

LOS TAPONES DE 15mm SE COLOCAN SOBRE LAS MADERAS MAS ANCHAS DE GROSOR(30mm).

LOS TAPONES DE 4x17mm SE COLOCAN SOBRE LAS MADERAS MAS ESTRECHAS DE GROSOR (16mm).

LOS TOPE-CLAVO SE PONDRAN EN FUNCIÓN DE COMO SE VAYA A COLOCAR EL MUEBLE, O BIEN EN EL SUELO, O BIEN EN EL LATERAL.

